

NOTES:  
 FOAM CELL TO INCLUDE VENT &  
 LATCH

OVERFLOW EXITS OUT PASSENGER  
 SIDE OF TANK AND IS FLUSH  
 WITH OUTSIDE OF TANK

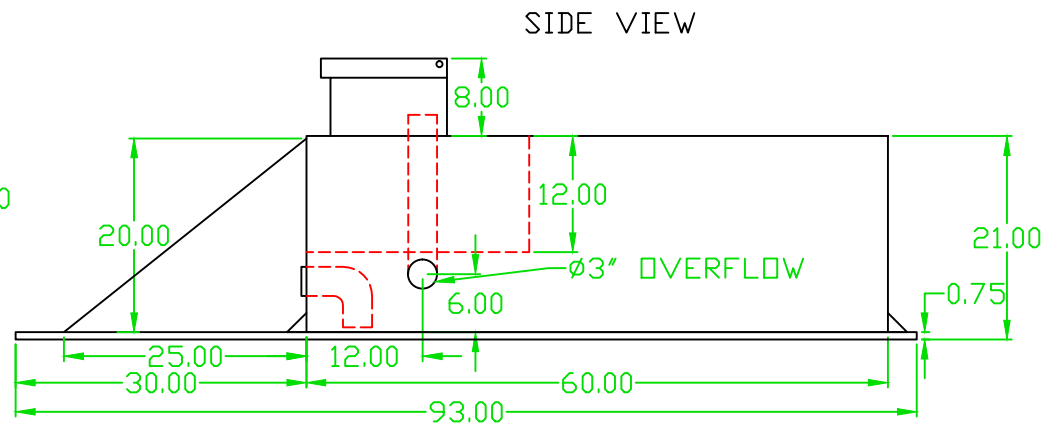
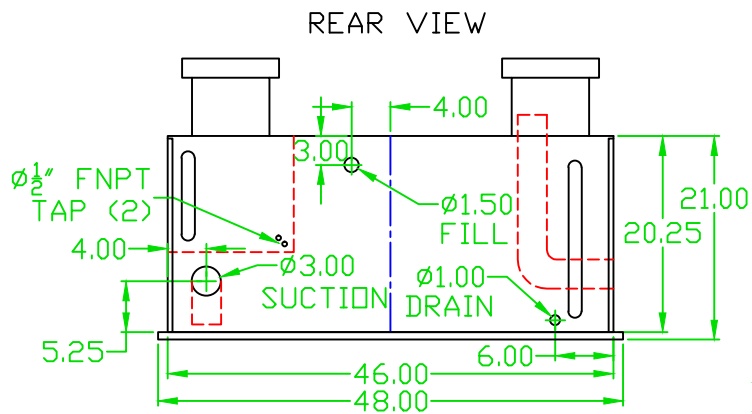
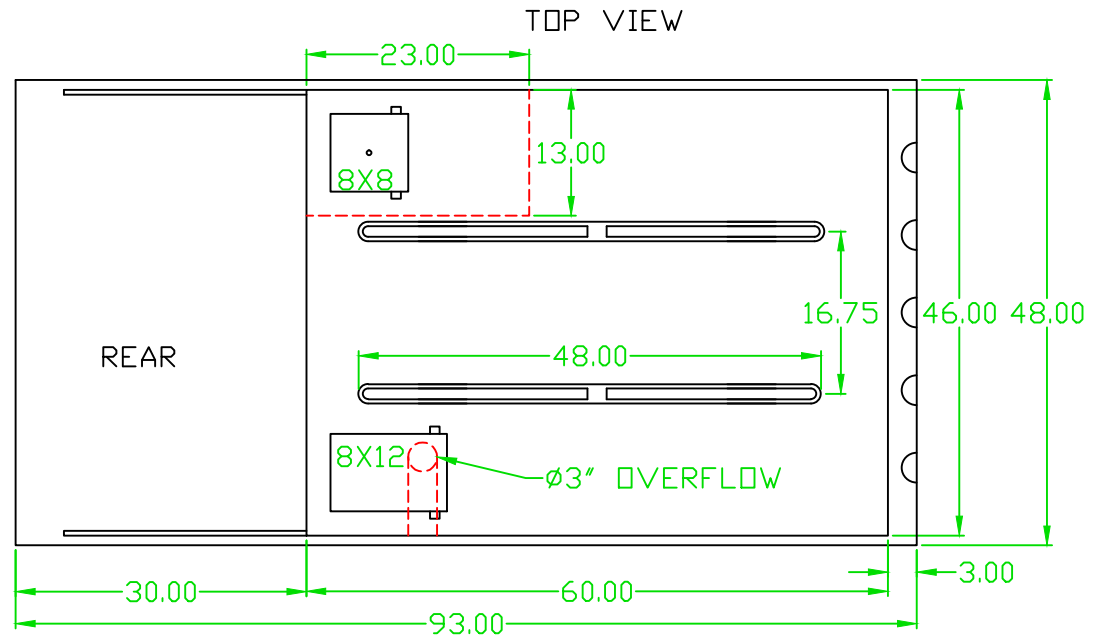

CUSTOM COMPOSITES  
 1018 E. Madison Street  
 Oklahoma City, OK 73111  
 1-877-912-6297  
 Phone: 405-424-2550  
 Fax: 405-424-2556  
 www.CustomCompositesOK.com

Customer's Signature and Date

Title

200 GAL 12 FOAM POLYPROPYLENE TANK (ECONOMY)

Customer

Foam Capacity  
 12 GALLONS

Material  
 POLYPROPYLENE

Water Capacity  
 200 GALLONS

TYPE:  
 ECONOMY TANK