

TOP VIEW

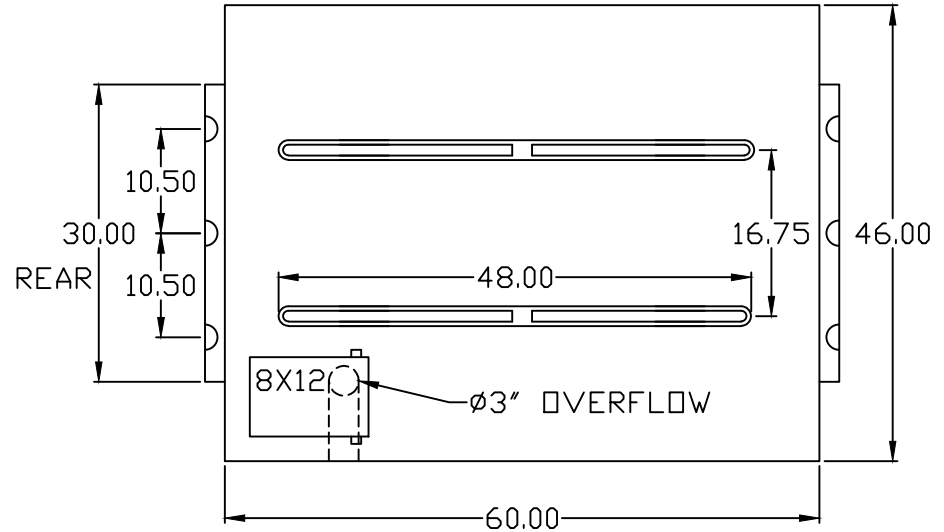

NOTES:
 OVERFLOW EXITS OUT PASSENGER
 SIDE OF TANK AND IS FLUSH
 WITH OUTSIDE OF TANK

REAR VIEW

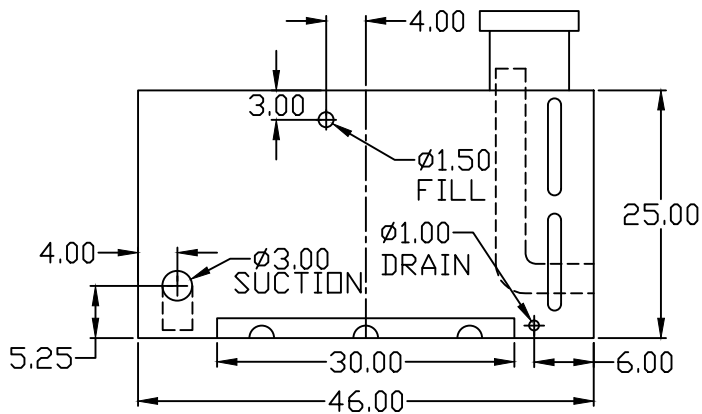

SIDE VIEW

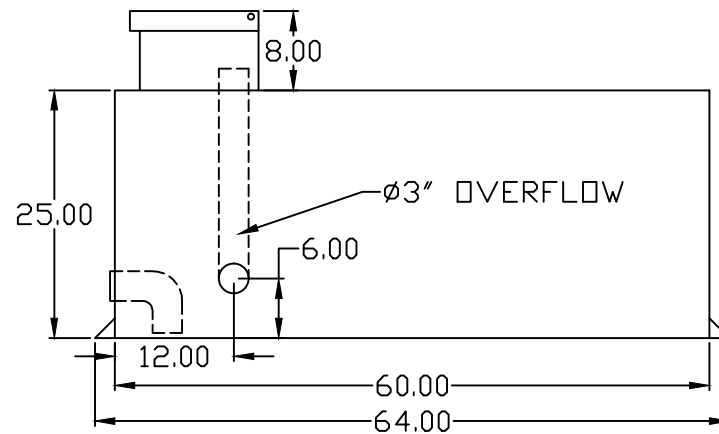

CUSTOM COMPOSITES
 1018 E. Madison Street
 Oklahoma City, OK 73111
 1-877-912-6297
 Phone: 405-424-2550
 Fax: 405-424-2556
 www.CustomCompositesOK.com

Customer's Signature and Date

Title

250 GALLON PROPYLENE TANK (ECONOMY)

Customer

Foam Capacity
 0 GALLONS

Material
 POLYPROPYLENE

Water Capacity
 250 GALLONS

TYPE:
 ECONOMY TANK