

NOTES:
 FOAM CELL TO INCLUDE VENT &
 LATCH

OVERFLOW EXITS OUT PASSENGER
 SIDE OF TANK AND IS FLUSH
 WITH OUTSIDE OF TANK

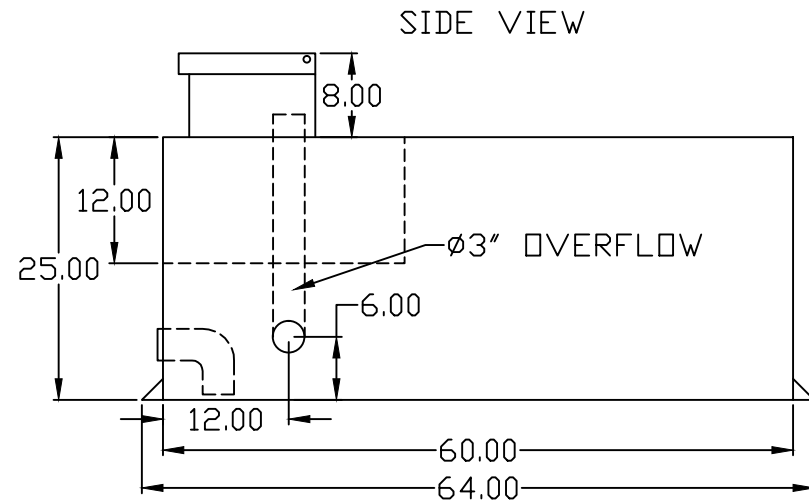
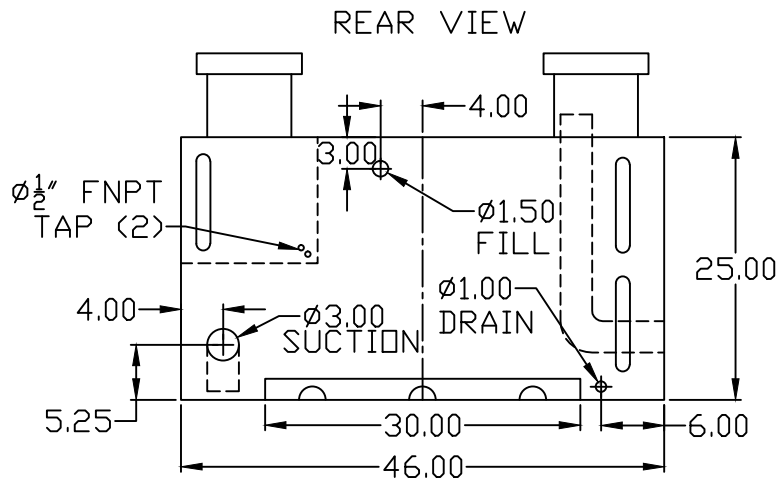

CUSTOM COMPOSITES
 1018 E. Madison Street
 Oklahoma City, OK 73111
 1-877-912-6297
 Phone: 405-424-2550
 Fax: 405-424-2556
 www.CustomCompositesOK.com

Customer's Signature and Date

Title

250 GAL 12 FOAM POLYPROPYLENE TANK (ECONOMY)

Customer

Foam Capacity
 12 GALLONS
 Water Capacity
 250 GALLONS

Material
 POLYPROPYLENE
 TYPE:
 ECONOMY TANK