

NOTES:
 FOAM CELL TO INCLUDE VENT &
 LATCH

OVERFLOW EXITS OUT PASSENGER
 SIDE OF TANK AND IS FLUSH
 WITH OUTSIDE OF TANK

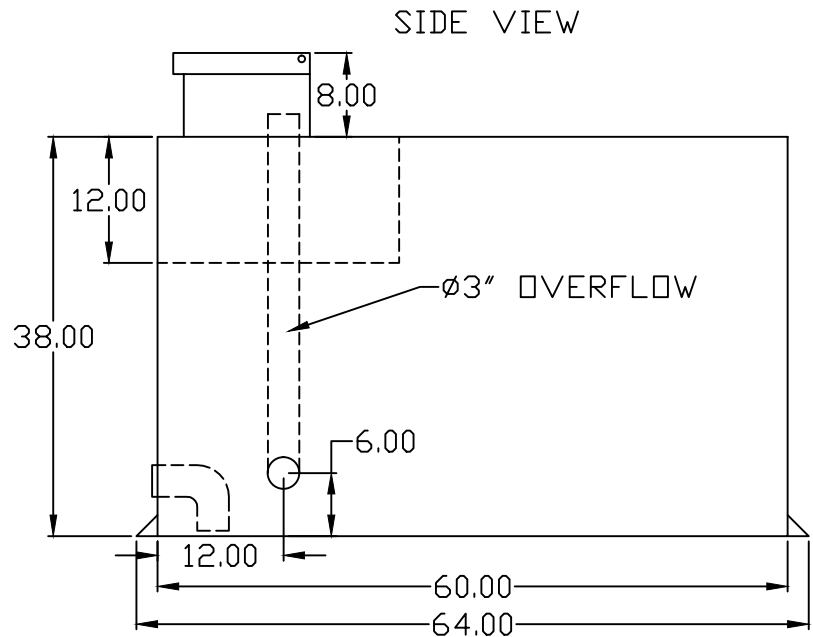
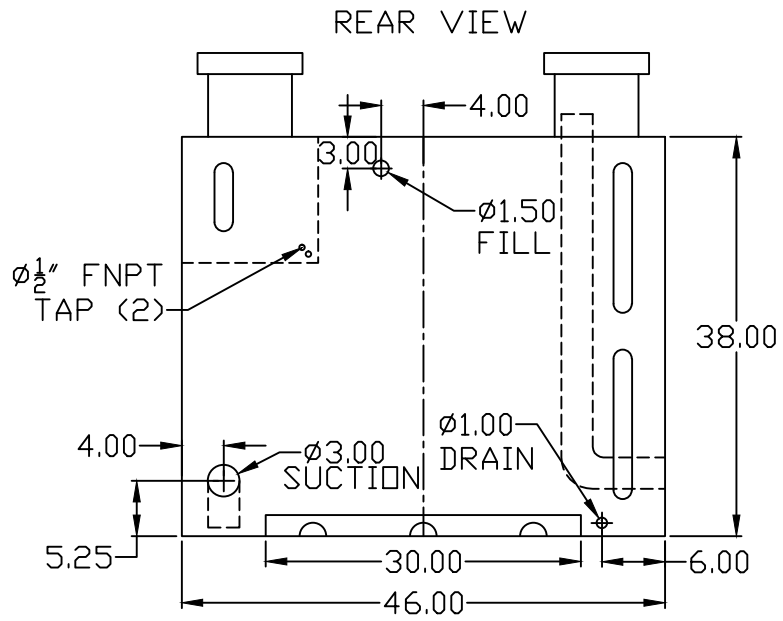
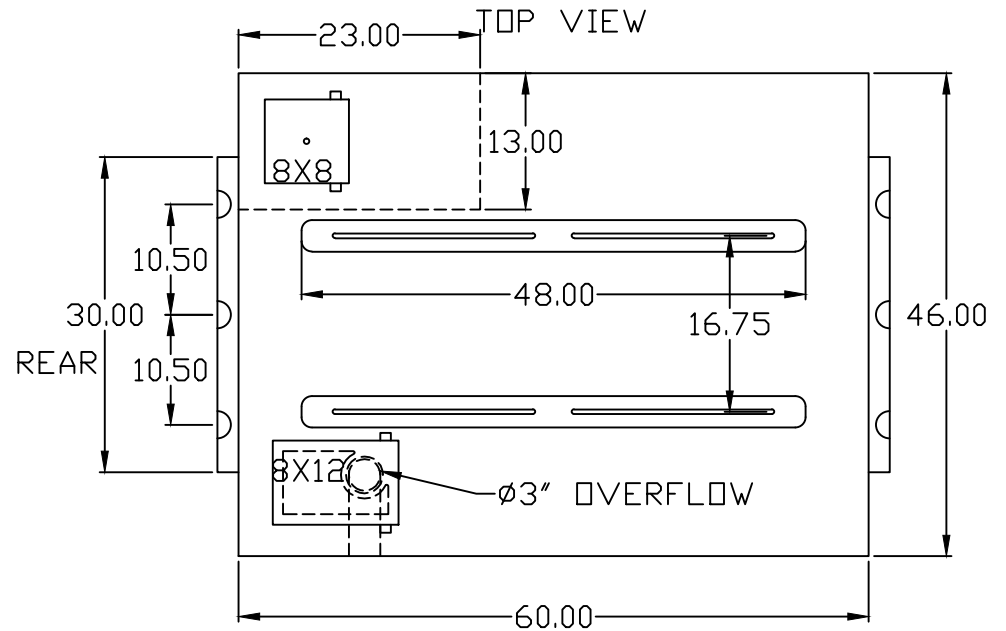

CUSTOM COMPOSITES
 1018 E. Madison Street
 Oklahoma City, OK 73111
 1-877-912-6297
 Phone: 405-424-2550
 Fax: 405-424-2556
 www.CustomCompositesOK.com

Customer's Signature and Date

Title
 400 GAL 12 FOAM POLYPROPYLENE TANK (ECONOMY)

Customer	Foam Capacity 12 GALLONS	Material POLYPROPYLENE
	Water Capacity 400 GALLONS	TYPE: ECONOMY TANK